

**M12 male 0° / M12 male 0° shielded Ethernet**

TPE 2x2x24AWG SF/UTP CAT5e bu UL/CSA, CM 7m

## USA

The resistance to aggressive media should be individually tested for your application. Further details on request.

Ethernet CAT5

Male straight – male straight

M12 – M12, 4-pole

D-coded

shielded

without cable sleeves

Further cable lengths on request.

Plastic housings with good resistance against chemicals and oils.

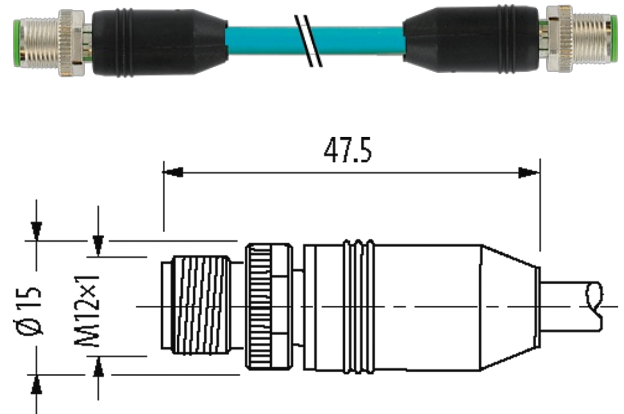
[Link to Product](#)**Illustration**

Product may differ from Image

**Approvals**

\* only for products with UL/CSA approved cable

**More Info**

EtherNet/IP

**Form**

Form 44511

**General data**

Standards	DIN EN 61076-2-101 (M12)
Mounting method	inserted, tightened
Pollution Degree	3
Temperature range	-25...+85 °C, depending on cable quality

**Cables**

Cable identification	S4U
Cable weight [g/m]	55,66
Material (wire)	Cu wire, tin plated
Construction (core)	7 × 0.203 mm
Diameter (core)	2 × 2 × 0.25 mm <sup>2</sup>
AWG	similar to AWG 24
Material (wire isolation)	HDPE
Wire-Ø incl. isolation	1.22 mm ±5%
Color/numbering of wires	(wh-or, or) + (wh-gn, gn)
Shield	yes
	min. 75%
Material (jacket)	TPE
Outer-Ø (jacket)	6.6 mm ±5%
Nominal voltage	1500 V AC
Temperature range (fixed)	-40...+80 °C
Temperature range (mobile)	-40...+80 °C
Bend radius (moving)	10 × outer Ø
No. of bending cycles (C-track)	max. 1 Mio. (25 °C)
Traversing distance (C-track)	max. 0.6 m
Travel speed (C-track)	max. 1.2 m/s
Acceleration (C-track)	max. 2.4 m/s <sup>2</sup>
Torsion stress	max. 3 Mio. (25 °C)
No. of torsion cycles	max. 3 Mio. (25 °C)
Torsion speed	60 cycles/min
No./diameter of wires	2 × 2 × 0.25 mm <sup>2</sup>
Wire isolation	HDPE (whor, or, whgn, gn)
C-track properties	1 Mio.
Material (jacket)	TPE (UL/CSA)
Jacket Color	blue
Outer Ø	6.6 mm ±5%
Bend radius (moving)	10 × outer Ø
Temperature range (fixed)	-40...+80 °C
Temperature range (mobile)	-40...+80 °C

#### Technical Data

Operating voltage	max. 60 V DC
Operating voltage (only UL listed)	max. 30 V DC
Rated surge voltage	1.5 kV
Operating current per contact	max. 4 A
Material group	IEC 60664-1, category I
No. of poles	4
Configuration	fully used
Transfer parameters	CAT5, Class D (ISO/IEC 11801:2002), (EN 50173-1)
Transfer rate	up to 100 Mbit/s full duplex
Coding	D-coded
LED display	no
Locking of ports	Screw thread (M12×1 mm) recommended torque 0.6 Nm, self-securing
Compression gland	M12 (SW13)
Protection	IP65, IP66K, IP67 inserted and tightened (EN 60529)

Locking material	Zinc die casting, matte nickel plated
Material	PUR
suitable for corrugated tube (internal Ø)	without

**Commercial data**

country of origin	DE
customs tariff number	85444290
EAN	4048879679213
eClass	27061801
Packaging unit	1

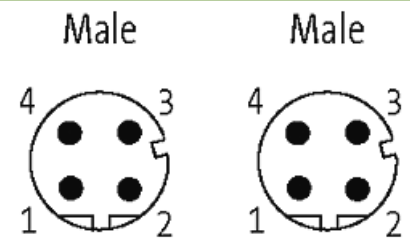
**Sketch**

Product may differ from Image